

COMPACT

Pravi klasik

PLOČASTI RADIJATORI



Compact je klasični pločasti radiator izrađen kako bi ispunio najviše zahtjeve za kvalitetom i učinkovitošću. Iako se cijevi vide na tradicionalan način, atraktivna gornja i bočna stranica na modelu Compact osigurava osjećaj ugone i ima diskretan izgled. Odabir modela je širok kao i kod svih naših pločastih radijatora.

PRIMJENA

| | |
|--------------|-----------|
| Kuhinja | ● ● ● ● ● |
| Hodnik | ● ● ● ● ● |
| Spavaća soba | ● ● ● ● ● |
| Kupaonica | ● ● ● |
| Dnevna soba | ● ● ● ● ● |



VISINA
300, 400, 450, 500,
600, 750, 900 mm

DULJINA
450 - 2100 mm

TIP
KMP 11, 21S, 22, 33

BOJE
RAL 9016 bijela. Druge
RAL boje su raspoložive
na zahtjev.

pločasti radijatori



Compact

Radijator 'Compact' ima atraktivne gornje i bočne pokrove te nudi zaštitu i lijep izgled. Njegov profil je također sigurno zaokružen. Cjevi su vidljive.

- Pribor uključen u pakovanje i cijenu: držači, 1 rotirajući odzračni otvor, 1 slijepi završetak, vijci i zatici.
- Instalacija: 4 ili 6 lijevanih traka za ovješnje za 2 ili 3 L-držača, moguće usko ili široko sastavljanje.
- Spojevi: 4 x Ø 1/2" (15/21).
- Boje: standardna boja RAL 9016.
Druge raspoložive boje: vidi str. 110.
- Pribor: vidi str. 104.



Compact

pločasti radijatori

volumen : l/m

| tip | 300 | 400 | 450 | 500 | 600 | 750 | 900 |
|-----|------|------|------|------|-------|-------|-------|
| 11 | 1,80 | 2,42 | 2,73 | 3,04 | 3,67 | 4,60 | 5,53 |
| 21S | 4,00 | 5,17 | 5,75 | 6,33 | 7,50 | 9,35 | 11,20 |
| 22 | 3,71 | 4,89 | 5,48 | 6,06 | 7,24 | 9,00 | 10,76 |
| 33 | 5,52 | 7,30 | 8,19 | 9,08 | 10,86 | 13,52 | 16,19 |

masa : kg/m

| tip | 300 | 400 | 450 | 500 | 600 | 750 | 900 |
|-----|-------|-------|-------|-------|-------|-------|-------|
| 11 | 9,60 | 12,82 | 14,43 | 16,04 | 19,27 | 24,10 | 28,93 |
| 21S | 15,60 | 21,17 | 23,95 | 26,73 | 32,30 | 39,45 | 46,60 |
| 22 | 17,90 | 23,78 | 26,71 | 29,65 | 35,52 | 44,33 | 53,14 |
| 33 | 26,67 | 35,84 | 40,43 | 45,02 | 54,19 | 67,95 | 81,71 |

| mjere traka za ovješnje | | |
|-------------------------|------|------|
| duljina | K | L |
| 1650 | 700 | 650 |
| 1800 | 750 | 750 |
| 1950 | 850 | 800 |
| 2100 | 900 | 900 |
| 2250 | 1000 | 950 |
| 2400 | 1050 | 1050 |
| 2550 | 1150 | 1100 |
| 2700 | 1200 | 1200 |
| 3000 | 1400 | 1350 |

Tip 11: radijatori duljine 1650 mm i veće: 6 traka za ovješnje.

Tip 21S, 22 i 33: Radijatori duljine 1650, 1800 i 1950 mm imaju samo 4 trake za ovješnje.

2100 mm i dulji: 6 traka za ovješnje.

instalacija

B = visina

C = duljina

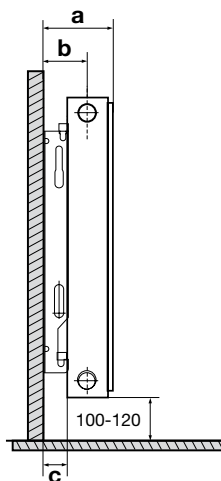
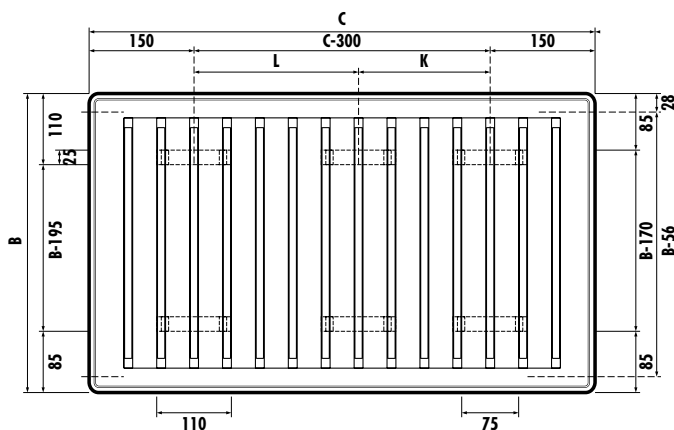

L-držać

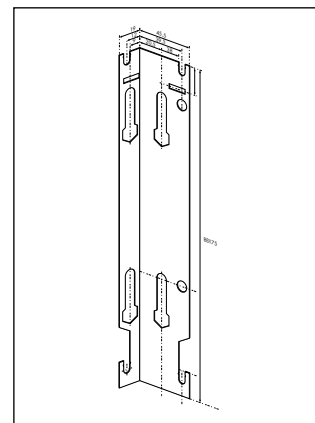

B = visina radijatora

usko sastavljanje

tip 11

a : 81 mm
b : 50 mm
c : 21,5 mm

tip 21s

a : 90 mm
b : 55 mm
c : 21,5 mm

tip 22

a : 127 mm
b : 74 mm
c : 21,5 mm

tip 33

a : 198 mm
b : 74 mm
c : 21,5 mm

široko sastavljanje

tip 11

a : 107 mm
b : 76 mm
c : 47,5 mm

tip 21s

a : 116 mm
b : 81 mm
c : 47,5 mm

tip 22

a : 153 mm
b : 100 mm
c : 47,5 mm

tip 33

a : 224 mm
b : 100 mm
c : 47,5 mm

spojevi

Drugi spojevi nisu mogući.

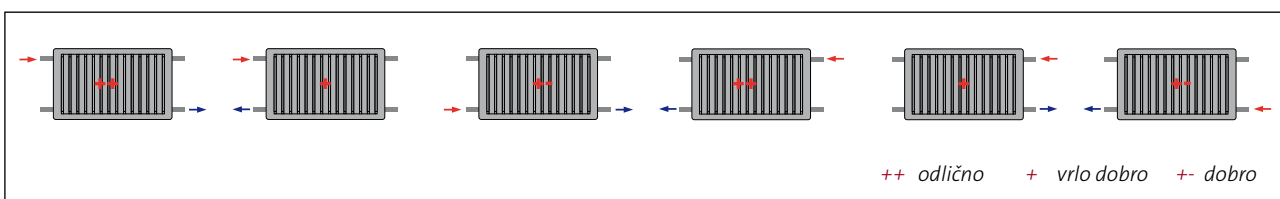

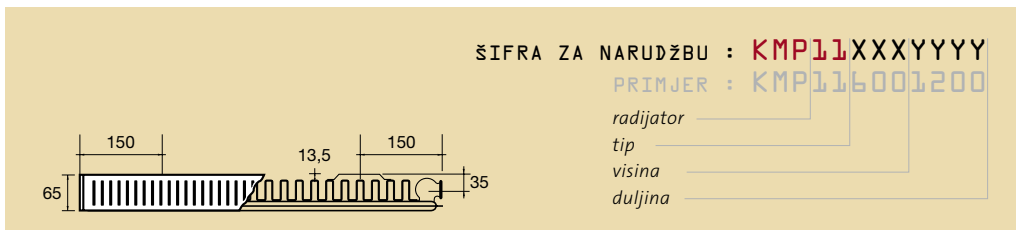

| duljina | W + cijena | visina | | | | | | |
|-------------|------------|--------|------|------|------|------|------|------|
| | | 300 | 400 | 450 | 500 | 600 | 750 | 900 |
| 450 | 75/65/20°C | 248 | 318 | 351 | 384 | 446 | 534 | 616 |
| | 90/70/20°C | 317 | 406 | 448 | 490 | 570 | 680 | 783 |
| 600 | 75/65/20°C | 331 | 424 | 468 | 512 | 595 | 712 | 821 |
| | 90/70/20°C | 423 | 541 | 598 | 653 | 760 | 907 | 1045 |
| 750 | 75/65/20°C | 413 | 530 | 585 | 640 | 744 | 890 | 1026 |
| | 90/70/20°C | 529 | 677 | 747 | 817 | 950 | 1134 | 1306 |
| 900 | 75/65/20°C | 496 | 635 | 702 | 768 | 893 | 1068 | 1231 |
| | 90/70/20°C | 635 | 812 | 896 | 980 | 1139 | 1361 | 1567 |
| 1050 | 75/65/20°C | 579 | 741 | 819 | 896 | 1042 | 1246 | 1436 |
| | 90/70/20°C | 740 | 947 | 1046 | 1143 | 1329 | 1588 | 1828 |
| 1200 | 75/65/20°C | 661 | 847 | 936 | 1024 | 1190 | 1424 | 1642 |
| | 90/70/20°C | 846 | 1082 | 1195 | 1307 | 1519 | 1814 | 2089 |
| 1350 | 75/65/20°C | 744 | 953 | 1053 | 1152 | 1339 | 1602 | 1847 |
| | 90/70/20°C | 952 | 1218 | 1345 | 1470 | 1709 | 2041 | 2350 |
| 1500 | 75/65/20°C | 827 | 1059 | 1170 | 1280 | 1488 | 1781 | 2052 |
| | 90/70/20°C | 1058 | 1353 | 1494 | 1634 | 1899 | 2268 | 2612 |
| 1650 | 75/65/20°C | 909 | 1165 | 1287 | 1407 | 1637 | 1959 | 2257 |
| | 90/70/20°C | 1163 | 1488 | 1643 | 1797 | 2089 | 2495 | 2873 |
| 1800 | 75/65/20°C | 992 | 1271 | 1404 | 1535 | 1786 | 2137 | 2462 |
| | 90/70/20°C | 1269 | 1624 | 1793 | 1960 | 2279 | 2722 | 3134 |
| 1950 | 75/65/20°C | | | | | 1934 | | |
| | 90/70/20°C | | | | | 2469 | | |
| 2100 | 75/65/20°C | | | | | 2083 | | |
| | 90/70/20°C | | | | | 2659 | | |

u skladu s EN 442 – 75/65/20 °C (ΔT50)

| W/m 90/70/20 °C vrijednost n | 705 | 902 | 996 | 1089 | 1266 | 1512 | 1741 |
|------------------------------|--------|--------|--------|--------|--------|--------|--------|
| | 1,3498 | 1,3451 | 1,3427 | 1,3404 | 1,3357 | 1,3287 | 1,3217 |

isporuka odmah

ŠIFRA ZA NARUŽBU : **KMP21XXXXYYY**

PRIMJER : **KMP216001200**

radijator

tip

visina

duljina

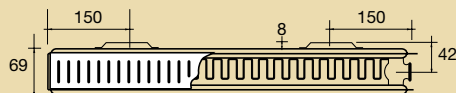

| duljina | W + cijena | visina | | | | | | |
|---------|------------|--------|------|------|------|------|------|------|
| | | 300 | 400 | 450 | 500 | 600 | 750 | 900 |
| 450 | 75/65/20°C | 361 | 448 | 490 | 530 | 607 | 718 | 823 |
| | 90/70/20°C | 463 | 575 | 627 | 678 | 777 | 917 | 1050 |
| 600 | 75/65/20°C | 481 | 598 | 653 | 706 | 809 | 957 | 1097 |
| | 90/70/20°C | 617 | 766 | 836 | 904 | 1036 | 1223 | 1400 |
| 750 | 75/65/20°C | 602 | 747 | 816 | 883 | 1012 | 1196 | 1372 |
| | 90/70/20°C | 772 | 958 | 1046 | 1130 | 1295 | 1529 | 1751 |
| 900 | 75/65/20°C | 722 | 896 | 979 | 1059 | 1214 | 1436 | 1646 |
| | 90/70/20°C | 926 | 1149 | 1255 | 1356 | 1553 | 1834 | 2101 |
| 1050 | 75/65/20°C | 842 | 1046 | 1142 | 1236 | 1416 | 1675 | 1920 |
| | 90/70/20°C | 1080 | 1341 | 1464 | 1582 | 1812 | 2140 | 2451 |
| 1200 | 75/65/20°C | 962 | 1195 | 1306 | 1412 | 1619 | 1914 | 2195 |
| | 90/70/20°C | 1235 | 1532 | 1673 | 1808 | 2071 | 2446 | 2801 |
| 1350 | 75/65/20°C | 1083 | 1345 | 1469 | 1589 | 1821 | 2153 | 2469 |
| | 90/70/20°C | 1389 | 1724 | 1882 | 2034 | 2330 | 2751 | 3151 |
| 1500 | 75/65/20°C | 1203 | 1494 | 1632 | 1766 | 2024 | 2393 | 2744 |
| | 90/70/20°C | 1544 | 1916 | 2091 | 2261 | 2589 | 3057 | 3501 |
| 1650 | 75/65/20°C | 1323 | 1643 | 1795 | 1942 | 2226 | 2632 | 3018 |
| | 90/70/20°C | 1698 | 2107 | 2300 | 2487 | 2848 | 3363 | 3851 |
| 1800 | 75/65/20°C | 1444 | 1793 | 1958 | 2119 | 2428 | 2871 | 3292 |
| | 90/70/20°C | 1852 | 2299 | 2509 | 2713 | 3107 | 3668 | 4201 |
| 1950 | 75/65/20°C | 1564 | 1942 | 2122 | 2295 | 2631 | 3110 | 3567 |
| | 90/70/20°C | 2007 | 2490 | 2718 | 2939 | 3366 | 3974 | 4551 |
| 2100 | 75/65/20°C | 1684 | 2092 | 2285 | 2472 | 2833 | 3350 | 3841 |
| | 90/70/20°C | 2161 | 2682 | 2927 | 3165 | 3625 | 4280 | 4901 |
| 2250 | 75/65/20°C | 1805 | 2241 | 2448 | 2648 | 3035 | 3589 | 4115 |
| | 90/70/20°C | 2315 | 2873 | 3137 | 3391 | 3884 | 4586 | 5252 |
| 2400 | 75/65/20°C | 1925 | 2390 | 2611 | 2825 | 3238 | 3828 | 4390 |
| | 90/70/20°C | 2470 | 3065 | 3346 | 3617 | 4142 | 4891 | 5602 |
| 2550 | 75/65/20°C | 2045 | 2540 | 2774 | 3001 | 3440 | 4067 | 4664 |
| | 90/70/20°C | 2624 | 3256 | 3555 | 3843 | 4401 | 5197 | 5952 |
| 2700 | 75/65/20°C | 2165 | 2689 | 2938 | 3178 | 3642 | 4307 | 4938 |
| | 90/70/20°C | 2778 | 3448 | 3764 | 4069 | 4660 | 5503 | 6302 |
| 3000 | 75/65/20°C | 2406 | 2988 | 3264 | 3531 | 4027 | 4785 | 5487 |
| | 90/70/20°C | 3087 | 3831 | 4182 | 4521 | 5178 | 6114 | 7002 |

u skladu s EN 442 – 75/65/20 °C (ΔT50)

| W/m 90/70/20 °C vrijednost n | 1029 | 1277 | 1394 | 1507 | 1726 | 2038 | 2334 |
|---------------------------------|--------|--------|--------|--------|--------|--------|--------|
| | 1,3668 | 1,3620 | 1,3596 | 1,3572 | 1,3523 | 1,3451 | 1,3379 |

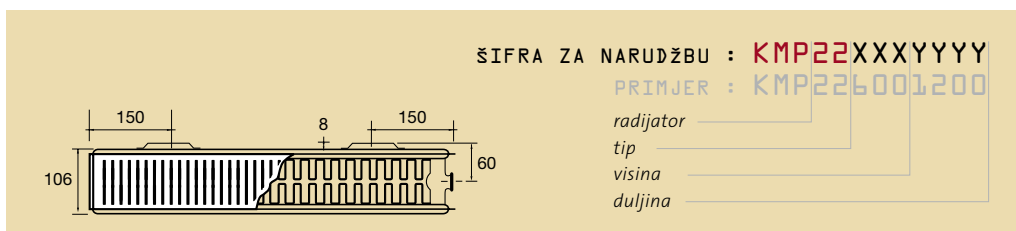

| duljina | W + cijena | visina | | | | | | |
|---------|------------|--------|------|------|------|------|------|------|
| | | 300 | 400 | 450 | 500 | 600 | 750 | 900 |
| 450 | 75/65/20°C | 474 | 601 | 661 | 718 | 824 | 968 | 1092 |
| | 90/70/20°C | 610 | 773 | 848 | 921 | 1056 | 1236 | 1392 |
| 600 | 75/65/20°C | 632 | 802 | 881 | 957 | 1099 | 1290 | 1456 |
| | 90/70/20°C | 813 | 1030 | 1131 | 1228 | 1408 | 1648 | 1856 |
| 750 | 75/65/20°C | 790 | 1002 | 1101 | 1196 | 1374 | 1613 | 1820 |
| | 90/70/20°C | 1016 | 1288 | 1414 | 1535 | 1760 | 2060 | 2321 |
| 900 | 75/65/20°C | 948 | 1202 | 1321 | 1436 | 1649 | 1935 | 2184 |
| | 90/70/20°C | 1220 | 1545 | 1697 | 1841 | 2112 | 2472 | 2785 |
| 1050 | 75/65/20°C | 1106 | 1403 | 1541 | 1675 | 1924 | 2258 | 2548 |
| | 90/70/20°C | 1423 | 1803 | 1979 | 2148 | 2464 | 2884 | 3249 |
| 1200 | 75/65/20°C | 1264 | 1603 | 1762 | 1914 | 2198 | 2580 | 2912 |
| | 90/70/20°C | 1626 | 2060 | 2262 | 2455 | 2816 | 3296 | 3713 |
| 1350 | 75/65/20°C | 1422 | 1804 | 1982 | 2153 | 2473 | 2903 | 3276 |
| | 90/70/20°C | 1829 | 2318 | 2545 | 2762 | 3168 | 3708 | 4177 |
| 1500 | 75/65/20°C | 1580 | 2004 | 2202 | 2393 | 2748 | 3225 | 3641 |
| | 90/70/20°C | 2033 | 2576 | 2828 | 3069 | 3521 | 4121 | 4641 |
| 1650 | 75/65/20°C | 1737 | 2204 | 2422 | 2632 | 3023 | 3548 | 4005 |
| | 90/70/20°C | 2236 | 2833 | 3110 | 3376 | 3873 | 4533 | 5105 |
| 1800 | 75/65/20°C | 1895 | 2405 | 2642 | 2871 | 3298 | 3870 | 4369 |
| | 90/70/20°C | 2439 | 3091 | 3393 | 3683 | 4225 | 4945 | 5569 |
| 1950 | 75/65/20°C | 2053 | 2605 | 2863 | 3110 | 3572 | 4193 | 4733 |
| | 90/70/20°C | 2642 | 3348 | 3676 | 3990 | 4577 | 5357 | 6033 |
| 2100 | 75/65/20°C | 2211 | 2806 | 3083 | 3350 | 3847 | 4515 | 5097 |
| | 90/70/20°C | 2846 | 3606 | 3959 | 4297 | 4929 | 5769 | 6497 |
| 2250 | 75/65/20°C | 2369 | 3006 | 3303 | 3589 | 4122 | 4838 | 5461 |
| | 90/70/20°C | 3049 | 3863 | 4241 | 4604 | 5281 | 6181 | 6962 |
| 2400 | 75/65/20°C | 2527 | 3206 | 3523 | 3828 | 4397 | 5160 | 5825 |
| | 90/70/20°C | 3252 | 4121 | 4524 | 4910 | 5633 | 6593 | 7426 |
| 2550 | 75/65/20°C | 2685 | 3407 | 3743 | 4067 | 4672 | 5483 | 6189 |
| | 90/70/20°C | 3455 | 4378 | 4807 | 5217 | 5985 | 7005 | 7890 |
| 2700 | 75/65/20°C | 2843 | 3607 | 3964 | 4307 | 4946 | 5805 | 6553 |
| | 90/70/20°C | 3659 | 4636 | 5090 | 5524 | 6337 | 7417 | 8354 |
| 3000 | 75/65/20°C | 3159 | 4008 | 4404 | 4785 | 5496 | 6450 | 7281 |
| | 90/70/20°C | 4065 | 5151 | 5655 | 6138 | 7041 | 8241 | 9282 |

u skladu s EN 442 – 75/65/20 °C (ΔT50)

| W/m 90/70/20 °C vrijednost n | 1355 | 1717 | 1885 | 2046 | 2347 | 2747 | 3094 |
|------------------------------|--------|--------|--------|--------|--------|--------|--------|
| | 1,3845 | 1,3757 | 1,3713 | 1,3669 | 1,3581 | 1,3449 | 1,3316 |

isporuka odmah

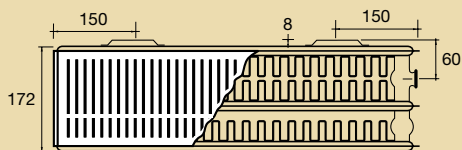

ŠIFRA ZA NARUŽBU : **KMP33XXXXYYY**

PRIMJER : **KMP336001200**

radijator

tip

visina

duljina



| duljina | W + cijena | visina | | | | | | |
|-------------|---------------|--------|------|------|------|-------|-------|-------|
| | | 300 | 400 | 450 | 500 | 600 | 750 | 900 |
| 450 | 75/65/20°C | 672 | 863 | 952 | 1037 | 1195 | 1404 | 1580 |
| | 90/70/20°C | 864 | 1107 | 1220 | 1328 | 1526 | 1787 | 2005 |
| 600 | 75/65/20°C | 896 | 1151 | 1270 | 1383 | 1594 | 1871 | 2107 |
| | 90/70/20°C | 1152 | 1476 | 1627 | 1770 | 2035 | 2382 | 2674 |
| 750 | 75/65/20°C | 1121 | 1439 | 1587 | 1729 | 1992 | 2339 | 2634 |
| | 90/70/20°C | 1440 | 1845 | 2033 | 2213 | 2544 | 2978 | 3342 |
| 900 | 75/65/20°C | 1345 | 1726 | 1904 | 2075 | 2390 | 2807 | 3161 |
| | 90/70/20°C | 1728 | 2214 | 2440 | 2655 | 3053 | 3573 | 4010 |
| 1050 | 75/65/20°C | 1569 | 2014 | 2222 | 2420 | 2789 | 3275 | 3688 |
| | 90/70/20°C | 2016 | 2583 | 2847 | 3098 | 3562 | 4169 | 4679 |
| 1200 | 75/65/20°C | 1793 | 2302 | 2539 | 2766 | 3187 | 3743 | 4214 |
| | 90/70/20°C | 2304 | 2952 | 3253 | 3540 | 4070 | 4764 | 5347 |
| 1350 | 75/65/20°C | 2017 | 2589 | 2857 | 3112 | 3586 | 4211 | 4741 |
| | 90/70/20°C | 2592 | 3321 | 3660 | 3983 | 4579 | 5360 | 6016 |
| 1500 | 75/65/20°C | 2241 | 2877 | 3174 | 3458 | 3984 | 4679 | 5268 |
| | 90/70/20°C | 2880 | 3690 | 4067 | 4425 | 5088 | 5955 | 6684 |
| 1650 | 75/65/20°C | 2465 | 3165 | 3491 | 3803 | 4382 | 5146 | 5795 |
| | 90/70/20°C | 3168 | 4059 | 4473 | 4868 | 5597 | 6551 | 7352 |
| 1800 | 75/65/20°C | 2689 | 3452 | 3809 | 4149 | 4781 | 5614 | 6322 |
| | 90/70/20°C | 3456 | 4428 | 4880 | 5310 | 6106 | 7146 | 8021 |
| 1950 | 75/65/20°C | 2913 | 3740 | 4126 | 4495 | 5179 | 6082 | 6848 |
| | 90/70/20°C | 3744 | 4797 | 5286 | 5753 | 6614 | 7742 | 8689 |
| 2100 | 75/65/20°C | 3137 | 4028 | 4444 | 4841 | 5578 | 6550 | 7375 |
| | 90/70/20°C | 4032 | 5166 | 5693 | 6195 | 7123 | 8337 | 9358 |
| 2250 | 75/65/20°C | 3362 | 4316 | 4761 | 5186 | 5976 | 7018 | 7902 |
| | 90/70/20°C | 4320 | 5535 | 6100 | 6638 | 7632 | 8933 | 10026 |
| 2400 | 75/65/20°C | 3586 | 4603 | 5078 | 5532 | 6374 | 7486 | 8429 |
| | 90/70/20°C | 4608 | 5904 | 6506 | 7080 | 8141 | 9528 | 10694 |
| 2550 | 75/65/20°C | 3810 | 4891 | 5396 | 5878 | 6773 | 7953 | 8956 |
| | 90/70/20°C | 4896 | 6273 | 6913 | 7523 | 8650 | 10124 | 11363 |
| 2700 | 75/65/20°C | 4034 | 5179 | 5713 | 6224 | 7171 | 8421 | 9482 |
| | 90/70/20°C | 5184 | 6642 | 7320 | 7965 | 9158 | 10719 | 12031 |
| 3000 | 75/65/20°C | 4482 | 5754 | 6348 | 6915 | 7968 | 9357 | 10536 |
| | 90/70/20°C | 5760 | 7380 | 8133 | 8850 | 10176 | 11910 | 13368 |

u skladu s EN 442 – 75/65/20°C (ΔT50)

| W/m 90/70/20°C vrijednost n | 1920 | 2460 | 2711 | 2950 | 3392 | 3970 | 4456 |
|--------------------------------|--------|--------|--------|--------|--------|--------|--------|
| | 1,3768 | 1,3651 | 1,3592 | 1,3533 | 1,3415 | 1,3238 | 1,3061 |