

# VIADRUS

Power of heating

## Hercules U22 C/D

### Cast-iron solid fuel boiler

Hercules U22 is an perfect general purpose boiler for low-cost solid fuel heating designated for residential houses and other smaller buildings. Quality of this boiler has been proved by its 200.000 well-satisfied users in the whole Europe. The Boiler has low chimney draught demands, it works both in natural or forced circulation heating systems and it is very easy and simple to use. Comfortable use of big firewood log pieces is enabled by big feeding door hole. It is possible to convert this solid fuel boiler to gas/oil boiler with jet burner (P/N versions).

#### Advantages:

- high service life of the cast-iron exchanger
- five year boiler block guarantee
- simple operation and maintenance
- optional boiler conversion from fuel combustion to gas or liquid fuels
- low demands on a chimney draught
- large stokehole of D version for firing almost 220 mm diameter lump wood
- possibility to firewood with humidity up to 20%
- wide range of power output according to the segment number

#### Fuel / fuel humidity:

- coke, 20~60 mm / <15%
- hard coal, 30~80 mm / <15%
- firewood, up to Ø 100 mm / <20%

#### Boiler output (according to section number):

- 11,7~58,1 kW



## Technical parameters

Section number		pcs	2	3	4	5	6	7	8	9	10
Boiler class according to EN 303 - 5		-					1				
Rated output	- U22 C, coke and hard coal	kW	11,7	17,7	23,3	29,1	34,9	40,7	46,5	52,3	58,1
	- U22 D, firewood	kW	-	-	20,0	25,0	30,0	35,0	40,0	45,0	49,0
Fuel consumption	- U22 C, coke	kg/hour	1,9	2,9	3,8	4,7	5,7	6,6	7,5	8,5	9,4
	- U22 C, hardcoal	kg/hour	2,0	3,0	4,0	4,9	5,9	6,9	7,9	8,9	9,9
	- U22 D, firewood	kg/hour	-	-	6,4	8,0	9,6	11,2	12,8	14,4	15,7
Efficiency	- U22 C, coke and hard coal	%					75~80				
	- U22 D, firewood	%	-	-			75				
Flue gases temperature	- U22 C, coke and hardcoal	°C					<280				
	- U22 D, firewood	°C	-	-			<320				
Dimensions	- height with / w/o control box	mm					1010 / 990				
	- width	mm					550				
	- depth L	mm	590	690	780	880	980	1070	1170	1260	1360
Weight	- U22 C	kg	198	218	252	282	312	347	377	417	448
	- U22 D	kg	-	-	247	275	305	340	365	410	441
Fire chamber depth		mm	150	240	340	430	530	620	720	810	910
Recommended firewood log length		mm	-	-	270	360	450	540	630	720	810
Chimney connection diameter		mm	156	156	156	156	156	156	156	176	176
Chimney draught		Pa	>12	>14	>16	>18	>20	>22	>24	>26	>28
Heating and return water connection		-					DN 50				
Water working overpressure		kPa					50~400				
Water testing overpressure		kPa					800				
Recommended water working temperature		°C					60~90				
Return water min. temperature		°C					60				
Water volume	- U22 C	l	26,1	31,5	36,2	40,9	45,6	50,3	55,0	59,7	64,4
	- U22 D	l	-	-	35,2	38,9	43,6	48,3	53,0	57,7	62,4
Noise level		dB					<65 dB (A)				

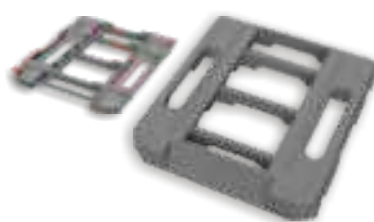
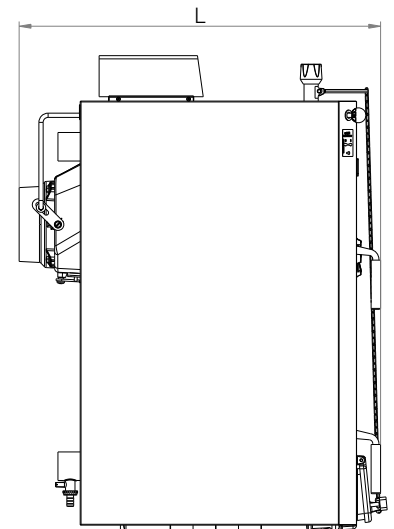
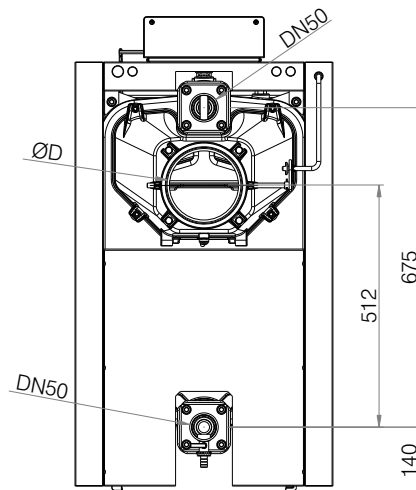
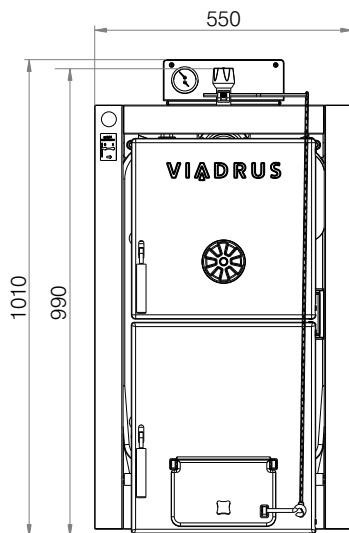

Cast-iron pedestal  
(optional accessory)

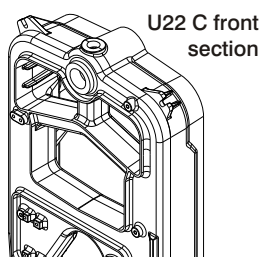

U22 C front  
section

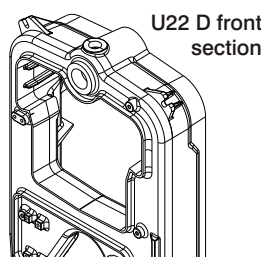

U22 D front  
section

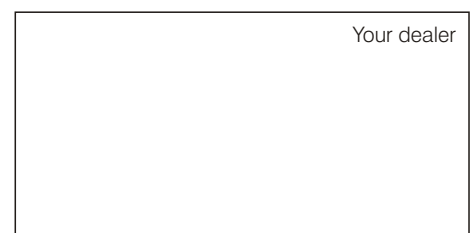

Your dealer